



INTAKE SYSTEMS FOR VEHICLES LISTED ARE 50 STATE LEGAL. SEE KNFILTERS.COM FOR CARB STATUS ON EACH PART FOR A SPECIFIC VEHICLE.

INSTALLATION INSTRUCTIONS

57-2570
FORD
2005-06 F-Series Super Duty
2005 Excursion
V8-5.4L

NOTE: This kit was not designed to fit vehicles with a body lift.

TOOLS NEEDED:

- Ratchet
- Extension
- 10mm Socket
- 13mm Socket
- T20 Torx Socket
- Flat Blade Screwdriver
- 4mm Allen Wrench
- 2.5mm Allen Wrench

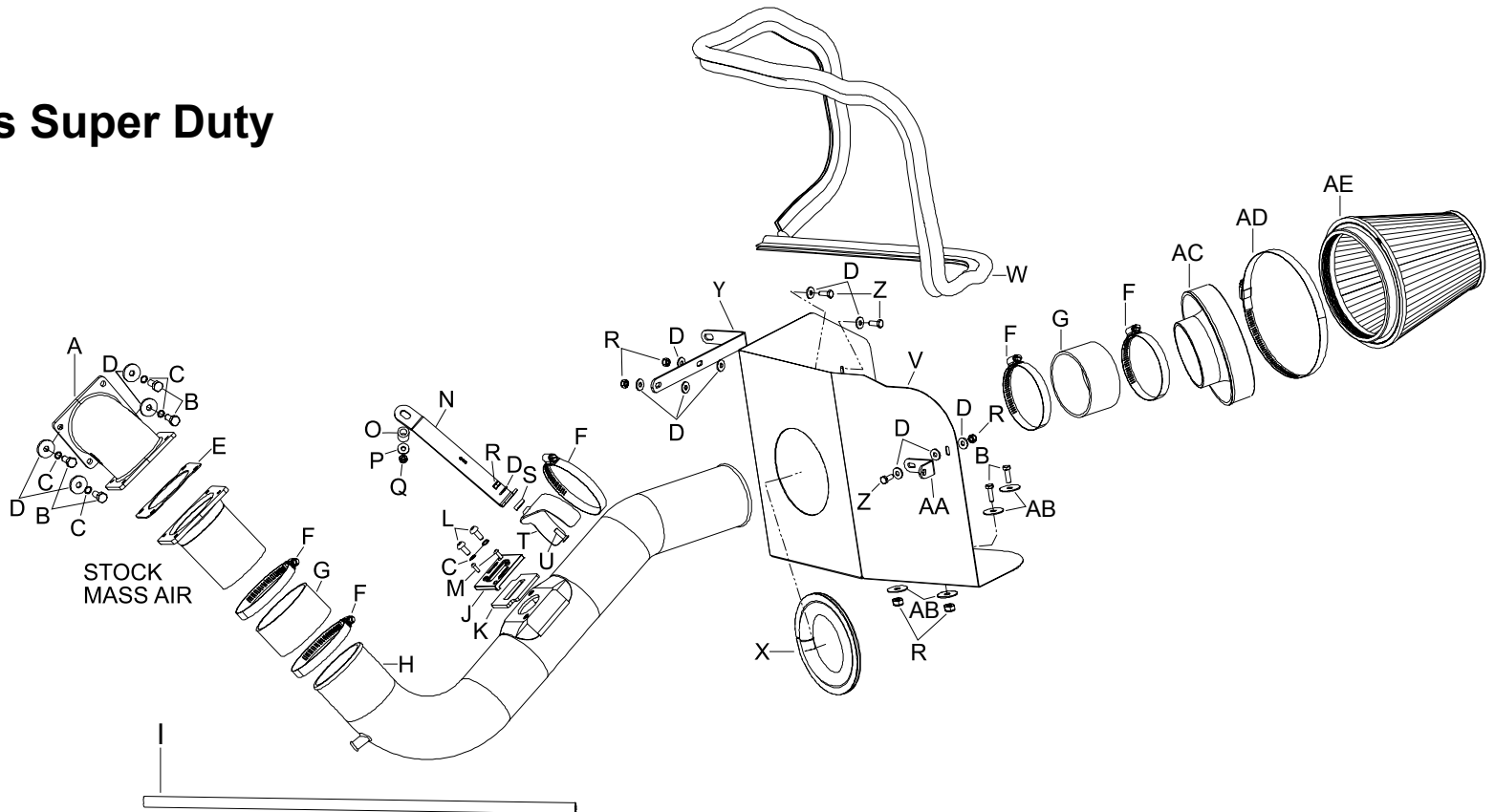

PARTS LIST:

Description	Qty.	Part #
A ADAPTER; #430	1	21516
B BOLT; 6MM-1.00 X 20MM HEX	6	07865
C WASHER; 1/4" LOCK, ZN	6	08198
D WASHER; 1/4"ID X 5/8" OD - SAE	14	08275
E GASKET; 1/16 NEOPRENE	1	09070
F HOSE CLAMP #56	5	08620
G HOSE; 3.5"ID X 2"L, SILICONE	2	08630
H INTAKE TUBE	1	087204A
I HOSE; 3/8"ID X 24"L, SILICONE	1	08493
J ADAPTER; NYLON, BLACK	1	21515
K GASKET; 3/16 PORON	1	09069
L BOLT, M6 X 1.00 X 16MM BTNHD	2	07730
M SCREW; M4-.7 X 12, BTNHD. SS	2	07726
N BRACKET; "L", FB/PC	1	26633
O SPACER; .625"OD X .375"ID X .625"	1	07849
P WASHER; 5/16"ID X 5/8"OD, FLAT	1	08276
Q NUT; 8MM NYLOCK	1	07542
R NUT; 6MM NYLOCK, HEX HEAD	6	07553
S WASHER; CONICAL, NYLON	1	08180
T BRACKET; SADDLE S/S	1	078855
U BOLT; 6MM-1.00 X 20MM F/H/A, SS	1	08376
V HEAT SHIELD	1	07668
W EDGE TRIM 83"	1	102503
X EDGE TRIM 16"	1	102469
Y BRACKET; MILD STL., FB/PC	1	010060
Z BOLT; M6-1.00 X 16MM HEX HD.	3	07703
AA BRACKET; L-BEND, FIN.	1	070812A
AB WASHER; 5/16-1.125" FENDER	4	08130
AC ADAPTER; #380	1	21512-1
AD HOSE CLAMP #140	1	08697
AE AIR FILTER	1	RU-5046

If you need any assistance please call 1-800-858-3333 to speak with a representative in our Customer Service Center before returning the product.

NOTE: FAILURE TO FOLLOW INSTALLATION INSTRUCTIONS AND NOT USING THE PROVIDED HARDWARE MAY DAMAGE THE INTAKE TUBE, THROTTLE BODY AND ENGINE.

TO START:

1. Turn off the ignition and disconnect the negative battery cable.

NOTE: Disconnecting the negative battery cable erases pre-programmed electronic memories. Write down all memory settings before disconnecting the negative battery cable. Some radios will require an anti-theft code to be entered after the battery is reconnected. The anti-theft code is typically supplied with your owner's manual. In the event your vehicles' anti-theft code cannot be recovered, contact an authorized dealership to obtain your vehicles anti-theft code.

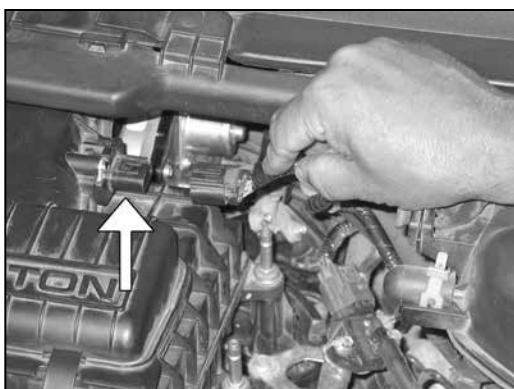

2. Disconnect the mass air sensor electrical connection.

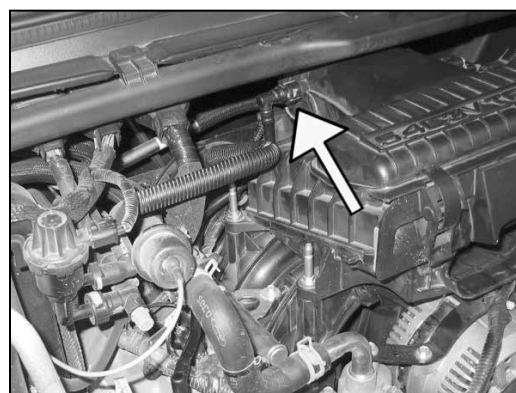

3. Disconnect the crank case vent hose from the factory air box.



4. Remove the nut which secures the stock intake tube to the mounting stud.



5. Unhook the factory fresh air tube from stock air box and radiator core support. Then remove the fresh air tube from the vehicle.

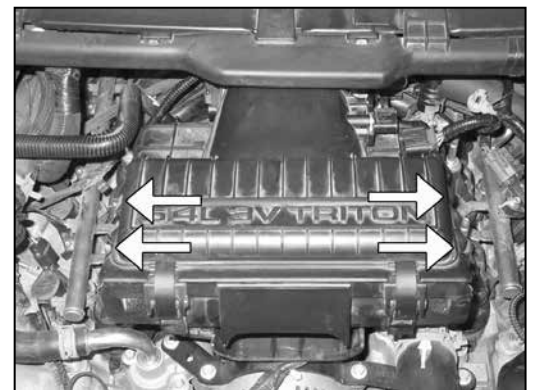

6. Remove the four air filter housing bolts shown.



7. Remove the factory air box from the vehicle.
NOTE: K&N Engineering, Inc., recommends that customers do not discard factory air intake.



8. Remove the bolt and nut that secure the mounting bracket for the stock fresh air intake tube and then remove the mounting bracket.

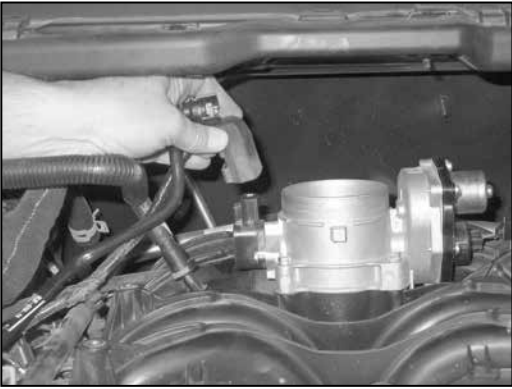

9. Disconnect the TPS sensor electrical connection from the throttle body.

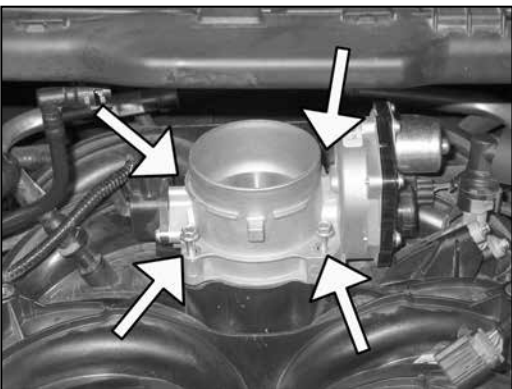

10. Remove the four throttle body mounting bolts.
NOTE: These bolts will be reused.



11. Lift the throttle body from the intake manifold. Then disconnect the throttle body motor electrical connection.
NOTE: Take care to avoid dropping debris down the intake manifold throat.



12. Using the factory mounting bolts from step #10, secure the throttle body to the K&N® throttle body adapter with the gasket as shown.



13. Install the throttle body assembly onto the intake manifold with the provided hardware as shown.

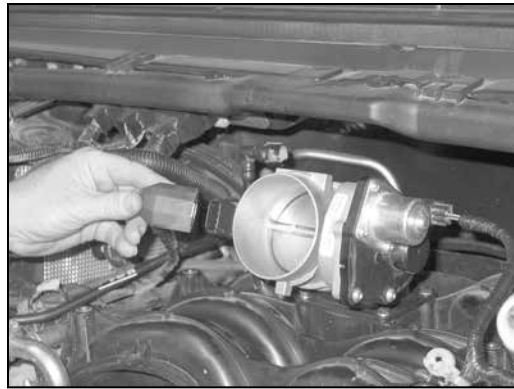

14. Reconnect the throttle body motor and TPS sensor electrical connections.

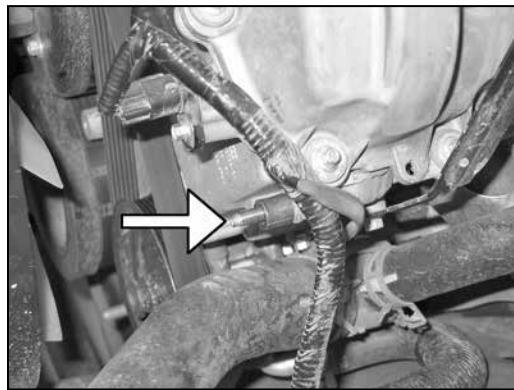

15. Install the provided spacer onto the threaded stud in the cylinder head.



16. Install the saddle bracket onto the tube mounting bracket (26633) with the provided hardware.



17. Install the tube mounting bracket assembly onto the threaded stud with the spacer installed in step #15. Then secure with the provided hardware.

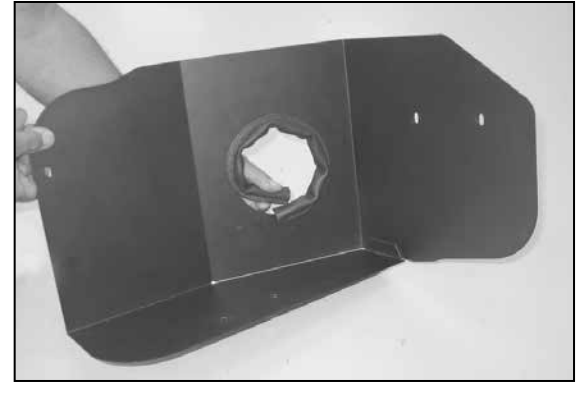

18. Install the short edge trim into the hole in the heat shield as shown.
NOTE: Some trimming of the edge trim may be necessary.

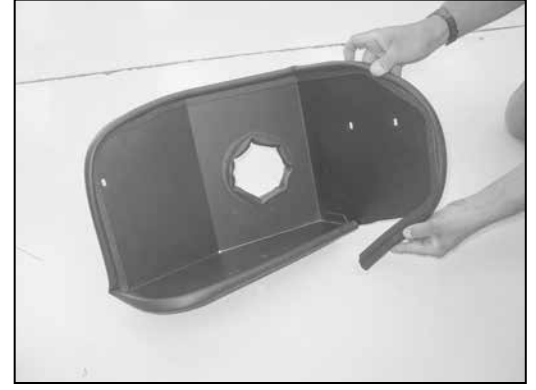

19. Install the long edge trim around the heat shield as shown.
NOTE: Some trimming of the edge trim may be necessary.

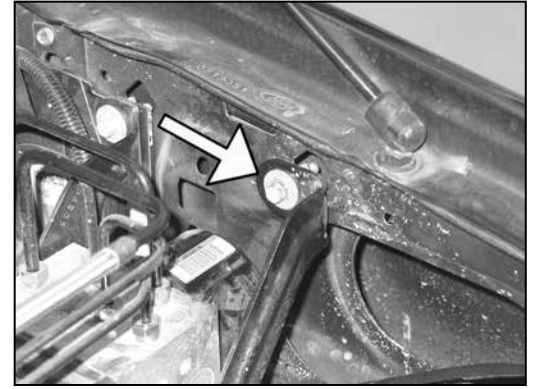

20. Remove the anti lock brake mounting bolt shown.

NOTE: This bolt will be reused.

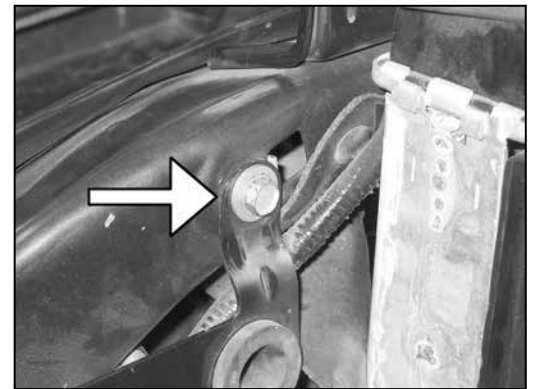

21. Remove the fresh air intake tube mounting bracket bolt shown from the radiator core support.
NOTE: This bolt will be reused.



22. Install the large "L" bracket (010060) onto the heat shield as shown with the provided hardware.
NOTE: Be sure to place a flat washer between the heat shield and bracket as a spacer. Do not completely tighten at this time.



23. Install the small "L" bracket (070812A) onto the heat shield as shown with the provided hardware.
NOTE: Be sure to place a flat washer between the heat shield and bracket as a spacer. Do not completely tighten at this time.

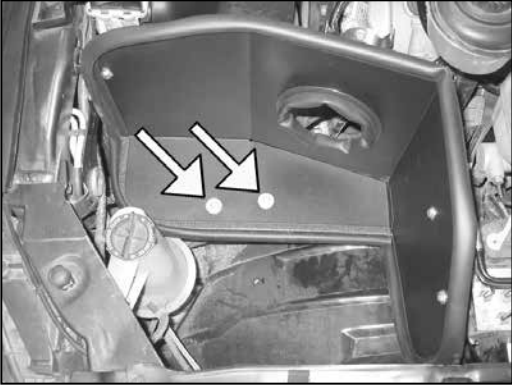

24. Place the heat shield onto the fender well so that it will align onto the lower bracket. Secure the heat shield to the lower bracket with the hardware provided as shown.

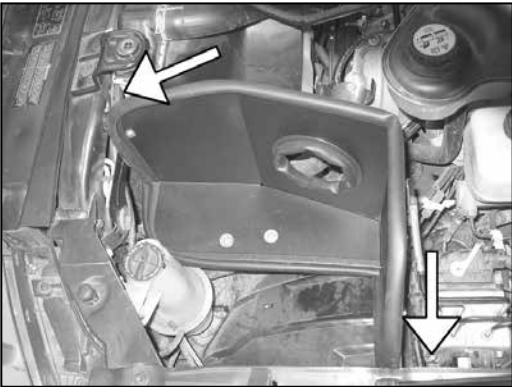

25. Secure the heat shield mounting brackets with the factory bolts removed in step #20 and #21. Tighten the mounting brackets to the heat shield.

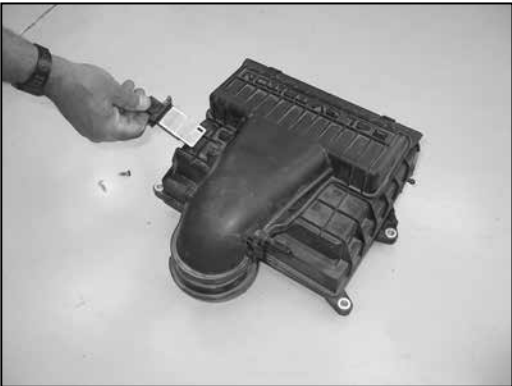

26. Remove the two screws securing the mass air sensor to the factory air box. Then remove the sensor from the air box.

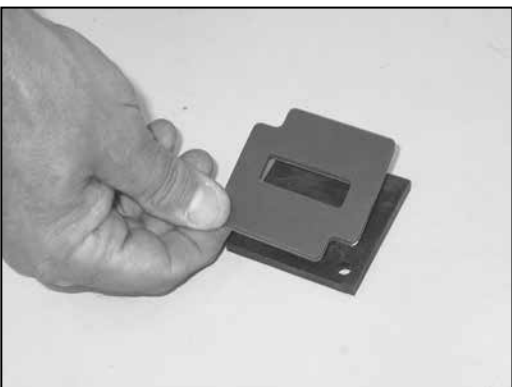

27. Install the provided gasket onto the K&N® mass air sensor adapter as shown.

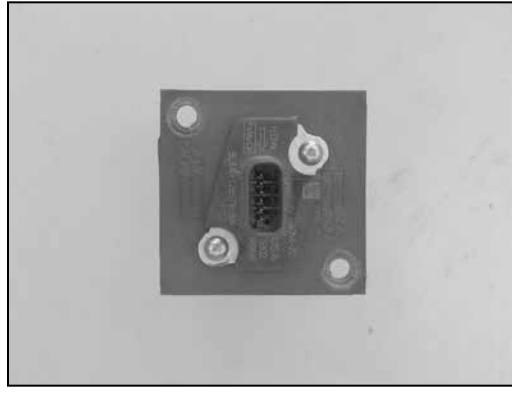

28. Install the mass air sensor into the K&N® adapter and secure with the provided hardware.

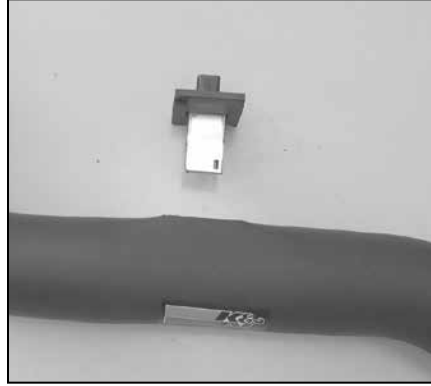

29. Install the mass air sensor assembly into the K&N® intake tube.

NOTE: The opening of the mass air sensor should be towards the filter end of the K&N® intake tube.

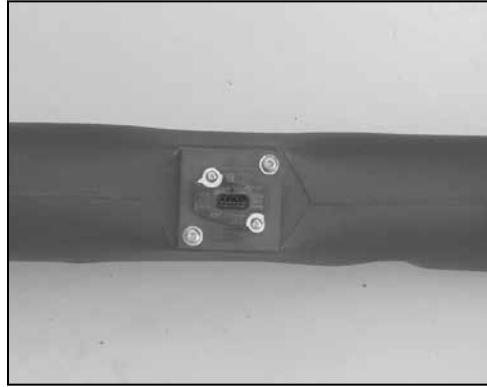

30. Secure the mass air sensor assembly to the K&N® intake tube with the provided hardware.



31. Install the silicone hose (08630) onto the throttle body and secure with the provided hose clamp.



32. Install the K&N® intake tube into the silicone hose at the throttle body and onto the saddle clamp, then secure with the provided hose clamps.

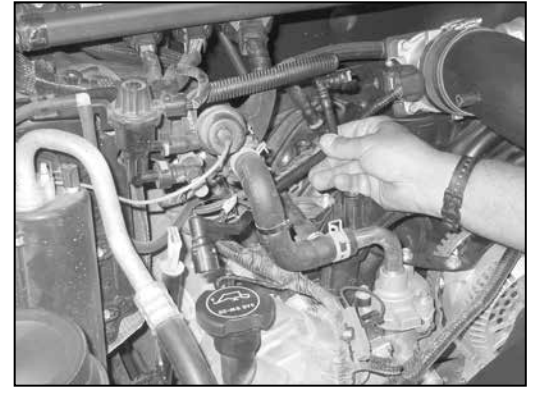

33. Remove the factory crank case vent hose from the valve cover.



34. Install the supplied crank case vent hose onto the valve cover fitting and then onto the K&N® intake tube as shown.

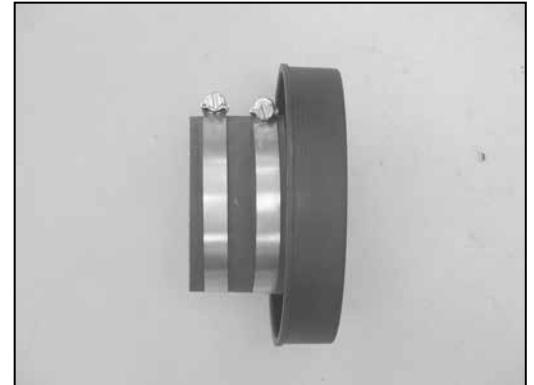

35. Install the silicone hose (08630) onto the filter adapter and secure with the provided hose clamp.



36. Install the filter adapter assembly into the K&N® filter and secure with the provided hose clamp.



37. Install the filter adapter assembly into the K&N® filter and secure with the provided hose clamp.

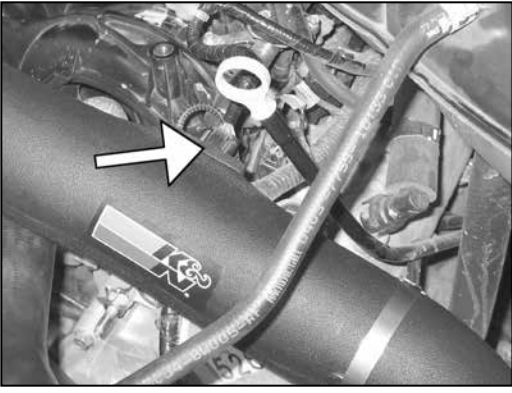

38. Install the filter adapter assembly into the K&N® filter and secure with the provided hose clamp.



39. Install the filter adapter assembly into the K&N® filter and secure with the provided hose clamp.

40. Reconnect the vehicle's negative battery cable. Double check to make sure everything is tight and properly positioned before starting the vehicle.

41. The C.A.R.B. exemption sticker, (attached), must be visible under the hood so that an emissions inspector can see it when the vehicle is required to be tested for emissions. California requires testing every two years, other states may vary.

42. It will be necessary for all K&N® high flow intake systems to be checked periodically for realignment, clearance and tightening of all connections. Failure to follow the above instructions or proper maintenance may void warranty.

ROAD TESTING:

1. Start the engine with the transmission in neutral or park, and the parking brake engaged. Listen for air leaks or odd noises. For air leaks secure hoses and connections. For odd noises, find cause and repair before proceeding. This kit will function identically to the factory system except for being louder and much more responsive.

2. Test drive the vehicle. Listen for odd noises or rattles and fix as necessary.

3. If road test is fine, you can now enjoy the added power and performance from your kit.

4. K&N Engineering, Inc., requires cleaning the intake system's air filter element every 100,000 miles. When used in dusty or off-road environments, our filters will require cleaning more often. We recommend that you visually inspect your filter once every 25,000 miles to determine if the screen is still visible. When the screen is no longer visible some place on the filter element, it is time to clean it. To clean and re-oil, purchase our filter Recharger® service kit, part number 99-5050 or 99-5000 and follow the easy instructions.

INTAKE SYSTEMS FOR VEHICLES LISTED ARE 50 STATE LEGAL. SEE KNFILTERS.COM FOR CARB STATUS ON EACH PART FOR A SPECIFIC VEHICLE.

* FREE K&N® decal To register your warranty, please see us online at knfilters.com/register. FREE K&N® decal *